

N300473-12
65101-11725-L

Installation Instructions

Honeycomb Shades

Corded / Corded TDBU / Corded Day & Night

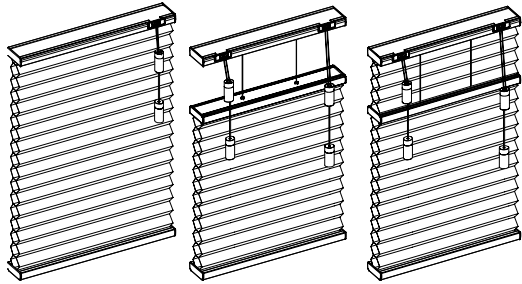

Getting Started

Remove the shade from the package. Save the packaging until the shade is installed and working to your satisfaction.

Tools Needed

- Power drill and drill bit
- Measuring tape
- Screwdriver
- Level
- Pencil



You will need to use the following fasteners for your particular mounting surface.

Surface	Fastener
Wood	1 1/4" Screws (Provide)
	3/4" Screws (Provide)
Drywall/Plaster	Wall Anchors, Expansion Bolts (Not Provide)
Metal	Sheet Metal Screws (Not Provide)

Check Component/Hardware:

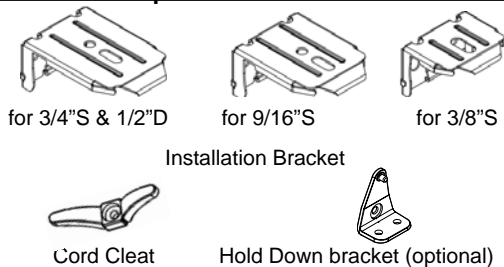

Hardware Standard Quantity

Order Width (X)	8 1/2" X 42"	42" X 75"	X 75"
Installation Bracket	2	3	4
1 1/4" Screw for 3/8"S Installation Bracket (for IB)	2	3	4
1 1/4" Screw for 3/4"S, 1/2"D, 9/16"S & 3/8"S (for OB) Installation Bracket	4	6	8
Cord Cleat	1pc for Corded, 2pcs for Corded TDBU & Day & Night		
3/4" Screw for Hold Down Bracket/ Cord Cleat	Hold Down Bracket qty*2 + Cord Cleat qty		
2" Screw for Installation Bracket with spacer	4	6	8
Hold Down Bracket (Optional)	2	2	2
Spacer (Optional)	2	3	4

Note: You may find more hardware parts than you actually need. In that case, feel free to set them aside for future use.

* Cord cleat is included.

* Optional hardware parts, such as spacers and hold down brackets, are available upon request.

Step 1: Bracket Installation

Measure 3" from both ends of the head rail. Mark the bracket location on the mounting surface. Proper alignment of brackets will make installation easier.

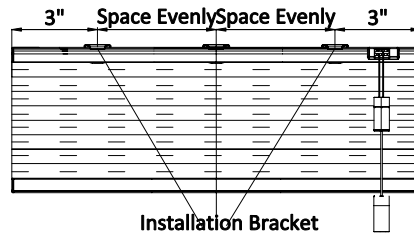

A. for 3/8" Single cell

Inside Mount:

Allocate a minimum distance of 5/8" from the edge of the wall to the top rail bracket screw hole. Use two 1 1/4" mounting screws to secure brackets.

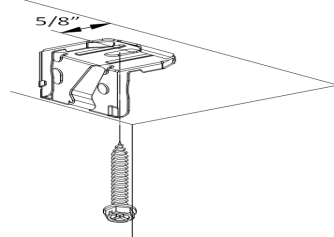

Outside Mount:

Allocate a minimum distance of 5/8" from the top rail

bracket screw hole to the top window frame. Use two 1 1/4" mounting screws to attach each bracket.

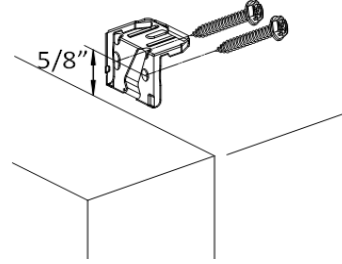

B. for 9/16" Single cell

Inside Mount:

Allocate a minimum distance of 5/8" from the edge of the wall to the top rail bracket screw hole. Use two 1 1/4" mounting screws to secure brackets.

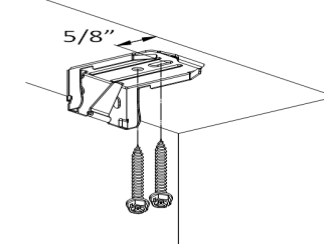

Outside Mount:

Allocate a minimum distance of 5/8" from the top rail bracket screw hole to the top window frame. Use two 1 1/4" mounting screws to attach each bracket.

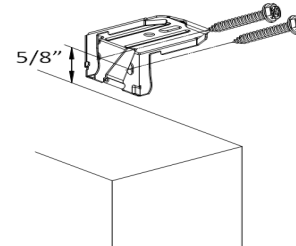

C. for 1/2" Double cell & 3/4" Single cell

Inside Mount:

Allocate a minimum distance of 5/8" from the edge of the wall to the top rail bracket screw hole. Use two 1 1/4" mounting screws to secure brackets. Use wall anchors for drywall or plaster wall.

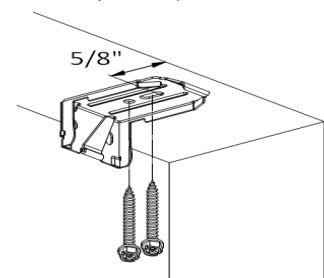

Outside Mount:

Allocate a minimum distance of 5/8" from the top rail bracket screw hole to the top window frame. Use two 1 1/4" mounting screws to secure brackets. Use wall anchors for drywall or plaster wall.

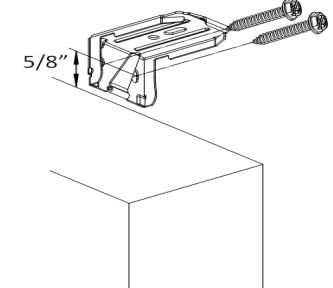

* For shallow mounting, using 2 flat head screws to secure the bracket in 45°.

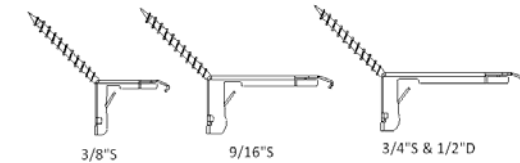

Step 2: Shade Installation

- Position the shade so that the front is facing you.
 - Insert the rail with an angle facing the window; hooking up with the bracket front side, and then push it upward to snap into the bracket.
- For proper installation, start with attaching the front rail to the bracket.

⚠ For easier installation, move the middle rail of corded TDBU a little bit off before installing the headrail.

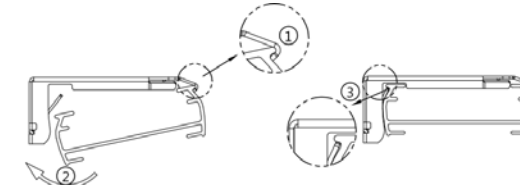

Step 3: How to Install Hold Down Brackets (optional)

A, For Hold Down Bracket.

Use two 3/4" screws to secure each hold down bracket.

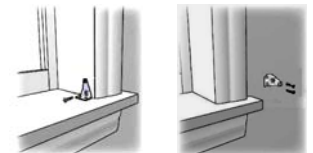

B. For Magnetic Hold Down

Use M3x15mm screw to secure the magnet catch at the below location. Make sure the magnet catch align with the pre-installed magnet on shade bottom rail.

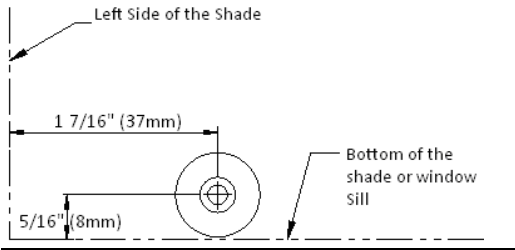

How to Reassemble Ellipse Safety Cord Connector

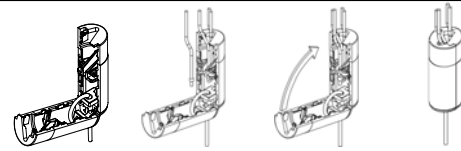

Our Shade comes equipped with an Ellipse Safety Cord Connector that prevents child strangulation. If the device comes apart, please refer to below steps:

1. Open the Ellipse Safety Cord Connector entirely.
2. Align all cords and slide them into the slot of Ellipse Safety Cord Connector;
3. Close the Ellipse Safety Cord Connector;
4. Pull the tassel cords and make sure it is closed tightly

Cleaning

Routine cleaning will help maintain the beauty of your shade. The shade can be cleaned by using a soft brush, vacuumed with a low suction hand-held vacuum, cleaned ultrasonically (specify that a mild solution must be used and that the head rail should never be immersed in liquid), or dampen a clean cloth with a warm water and mild detergent solution to dab the spot until it's gone (do not rub!).

Troubleshooting

Problem	Solution
For corded TDBU & Day & Night, if the bottom shade fabric not remain stacked (billowed on the windowsill), when the top was lowered	When lower the bottom shade, please pull the left side cord leftwards to lock the bottom rail. Please make sure the bottom rail is locked right above the windowsill first (if not locked, please try more times) before operating the top shade.

Step 4: Shade Operation

For Corded TDBU & Day & Night: when lowering the shade, pull the left cord to lower the bottom rail first and then pull the right cord to lower the middle rail. When raising the shade, reverse operation. Raise the middle rail first and then bottom rail.

Step 5: Cord Cleat

Install the cord cleat on the wall. Wrap the operating cords around the cord cleat for child safety. Always use the cord cleat to keep cords out of the reach of children. The cleat should be installed more than 64" (1.6m) from the door.

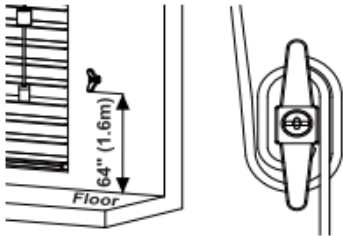

Remove the Shade

- For Corded, Fully raise the shade
- For Corded TDBU & Day & Night, Lower the mid rail
- Insert screwdriver into the gap between the back of the rail and the bracket. Gently maneuver the screwdriver toward yourself to pry the bracket.

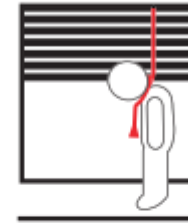
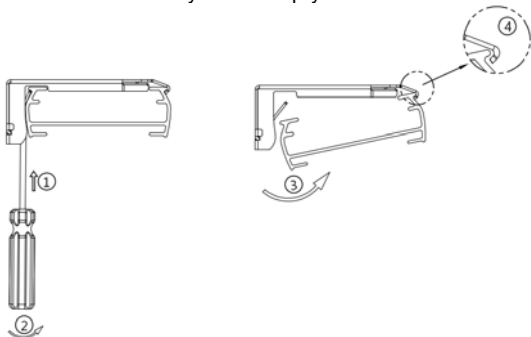

Window Blind Cord Can STRANGLE Your Child

- Children can strangle in the loop above the cord bead.
- Children can climb furniture to reach cords.
- Move crib and furniture away.
- Shorten cords to prevent reach.
- Keep cords separate. Twisted or knotted cords can create a loop.
- Keep all cords out of children's reach.

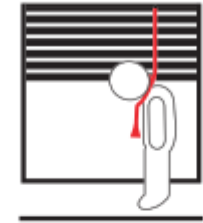

La cuerda de la persiana puede ESTRANGULAR su niño

- Los niños se pueden estrangular en el lazo por encima del cordón.
- Los niños pueden subir los muebles para alcanzar las cuerdas.
- Mueva la cuna y los muebles.
- Acorte las cuerdas para evitar el alcance.
- Mantenga las cuerdas separadas. Los cordones retorcidos o anudados pueden crear un lazo.
- Mantenga todas las cuerdas fuera del alcance de los niños.