

Installation Instructions

Cordless

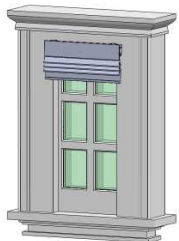

Getting Started

- Please take a moment to review the following installation guide.
- Please leave shade in folded open position for ease of installation
- Be sure to keep all components and packaging until shade is fully installed



Recommended Tools

- Power drill and Drill bit
- Tape Measure
- Screwdriver
- Level
- Pencil







You will need to use the following fasteners for your particular mounting surface.

Installation Screws

Surface	Fastener
Wood	1 1/2" Screw (Provide) 
Drywall/Plaster	Wall Anchors, Expansion Bolts (Not Provided) 
Metal	Sheet Metal Screws (Not Provide) 

Hardware Included

Name	Picture
Outside Mount Male Bracket	
Inside Mount Male Bracket	
1 1/2" Screw	
2 1/2" Screw for bracket with spacer block (optional)	
Spacer Block (optional)	

1. To mark the brackets

Step 1: Position the shade inside or outside (depending on the version) the window opening. Make a mark along the end of the headrail on both sides on the mounting surfaces.

Step 2: Mark the positions where you will install the brackets, 3.5" in from each side of the shade.

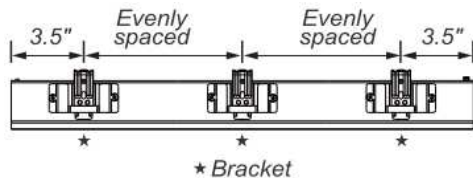

**** Proper alignment of brackets will make installation easier.**

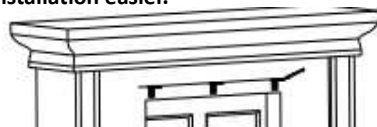

2. To mount the shade inside a window frame

When flush inside mount, allocate a min. distance of 1 3/8" from the edge of the wall to the center of the screw hole. Use one 1 1/2" Screw to secure brackets.

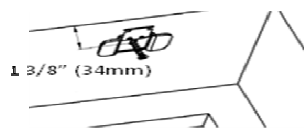

3. To mount the shade outside a window frame

Allocate a minimum distance of 2" from the end of brackets to the top window frame, and Fix the bracket with two 1 1/2" screws.

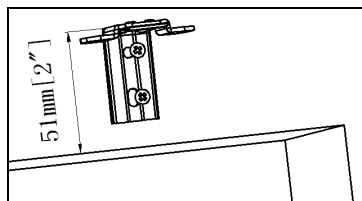

Note: If spacer block is required for outside mount, please follow the following guide:

Please always make sure the raised side of the spacer block is against the bracket. If 2pcs spacer blocks are required, please follow the below illustration to attach the spacer blocks. Mount the combination of the bracket and spacer block with two 2 1/2" screws

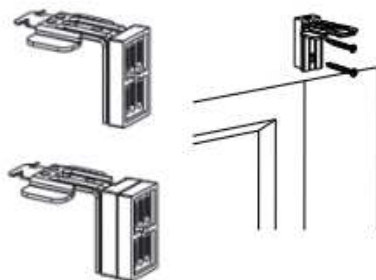

4. To mount the shade

Shade installation is the same for both inside and outside mount applications

Step 1: Align the female bracket preinstalled on the shade to the male bracket.

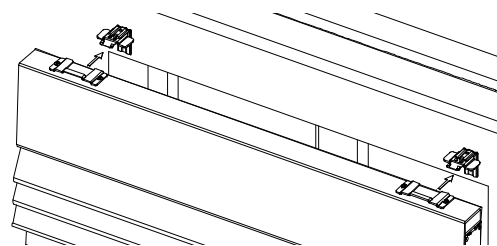

Step 2: Slide the female bracket on the shade into the male bracket until it snaps into place. **If more than two brackets are used, it is recommended to attach the center female bracket into the male bracket first, and then attach the female bracket at each end.**

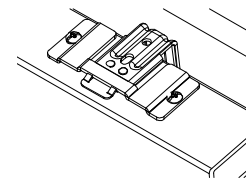
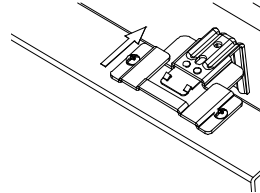

Step 3: If the female brackets are a little off from the male bracket, the position of the female brackets can be adjusted by moving left or right 5/16".

Note: To make the installation easily, please do the best to eliminate the deviation of the placement of bracket, to make sure the male bracket is in the middle of the female bracket.

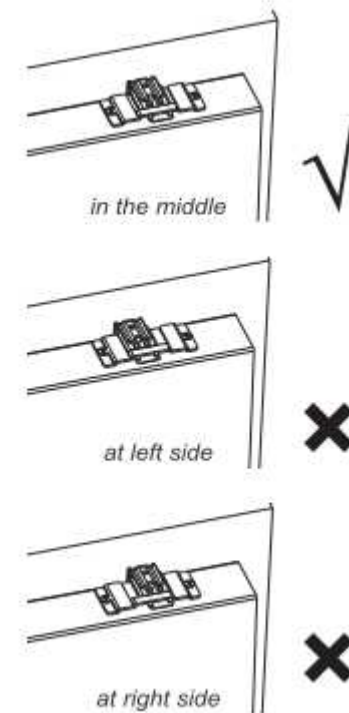

5. To operate the installed cordless

Pull gently on the handle in the middle of the roller shade at the back to lock the shade in the desired position. To raise the shade, pull gently down on the handle a short distance to unlock the shade and the shade will rise automatically.

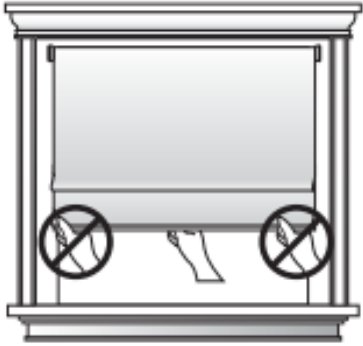

Note: To ensure long-term performance of your shade, always grab the shade handle when operating the shade. The handle is located at the back of the shade. Do not grab the bottom of the shade.

6. To operate the installed cordless with wand

Stretch the wand to the back of roman shade and try to use the hook to gently pull downward the handle which is at the center of roman shade at back.

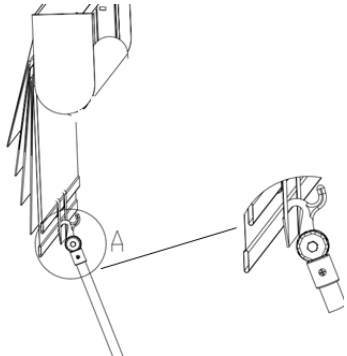

7. To remove the shade

Step 1: Insert the screwdriver into the space between the female and male bracket. Separate male bracket apart from the female bracket by revolving the screwdriver as pictured below. **If more than two brackets are used, it is recommended to separate the bracket at each end first, and then separate the one in the center.**

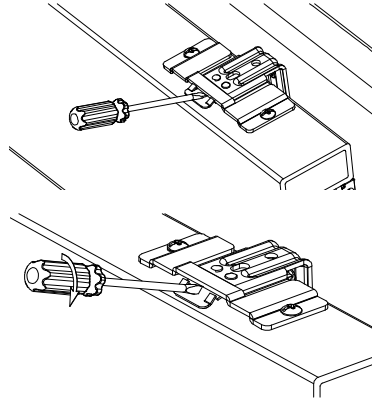

Step 3: Gently pull the shade outward to remove the shade.

