

Installation Instructions

BelleVue Shade

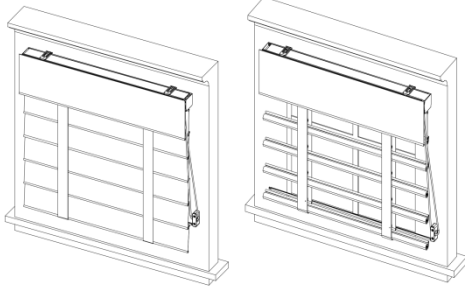

Getting Started

Remove shade from package. Save packaging until shade is installed and working to your satisfaction.

Tools:

- Power drill
- Tape measure
- Screwdriver
- Level
- Pencil



You will need to use the following fasteners for your particular mounting surface.

Installation Screws

Surface	Fastener
Wood	8 x 1 1/4" Screws (Provided)
	1 7/8" Screw (Provided)
Drywall/Plaster	Wall Anchors, Expansion Bolts (Not Provide)
Metal	Sheet Metal Screws (Not Provide)

Hardware Included

Name	Picture
1 1/4" Screw	
Installation Bracket	
1 7/8" Screw for Tension Device	
Spacer Block (optional)	
2" Screw for bracket with spacer block (optional)	

Step 1: To install bracket

Measure 3" from both ends of the head rail. Mark bracket location on the mounting surface.

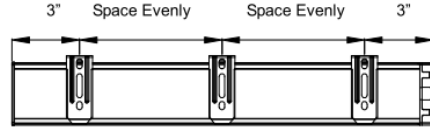

When 42" < the shade width ≤ 63", the center bracket should be 1 3/16" off from the center of the shade.

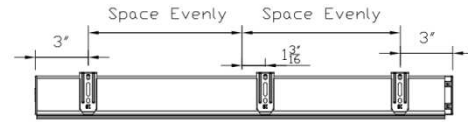

** Proper alignment of brackets will make installation easier.

Inside Mount

• Allocate a minimum distance of 5/16" from wall to the front of brackets.

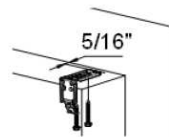

• Use two 1 1/4" screws to secure brackets. Use wall anchors for drywall or plaster wall.

Outside Mount

• Allocate a minimum distance of 5/16" from wall to the bottom of the bracket as right drawing.

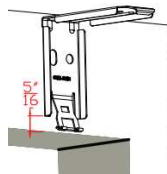

• Use two 1 1/4" screws to attach each bracket. Use wall anchors for drywall or plaster wall.

Note: If spacer block is required for outside mount, please follow the following guide:

Please always make sure the raised side of the spacer block is against the bracket.

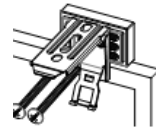

If 2pcs spacer blocks are required, please follow the right illustration to attach the spacer blocks. Mount the combination of the bracket and spacer block with two 2" screw.

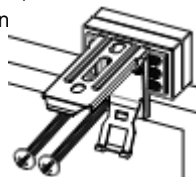

The window frame protrudes from wall by 0-10mm, one spacer block is used.	
The window frame protrudes from wall 10-18mm, two spacer blocks are used.	

Step 2: To install the shade

Position head rail at an angle so that it is hooked to the front of the bracket. Then push it upward to snap into the bracket.

⚠ For proper installation, start with attaching the front rail to the bracket.

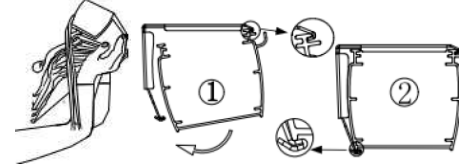

***The Shade is heavy. Please be careful!**

Step 3: To install the tension device

Measure and mark the location where the tension device will be mounted. Mount the tension device with 2 pcs of 2" screw. The mounting screws must be secured into a solid surface or molly. When positioning and mounting the tension device, make sure the cord is taut without stretching, twisting or crossing, and the tension device and control cord does not interfere with raising or lowering the shade.

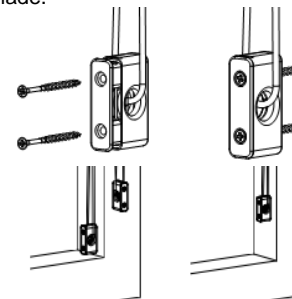

Step 4: To operate the shade

Pull cord to operate shade. Tension device must be fully tightened before operating the shade.

a. Pull front cord to raise the shade and roll the

fabric slats. For EZ Release, pull the front cord once, the shade will raise.
b. Pull back cord to lower the shade and close the fabric slats. For EZ Release, pull the back cord once, the shade will lower automatically.

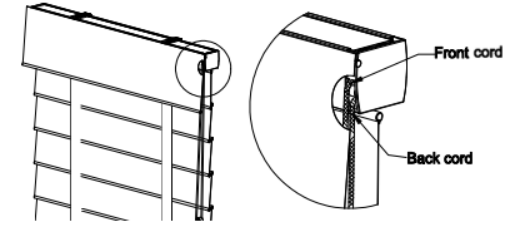

To remove the Shade

Raise the shade, and then roll up the valance and the top-fixed slat by hand to see the installation bracket position.

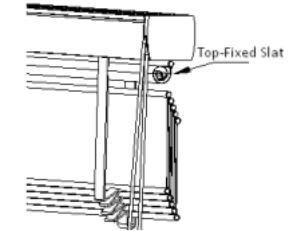

Gently insert the flat screwdriver into the back slot of the installation bracket and turn clockwise. Remove the shade as below drawing.

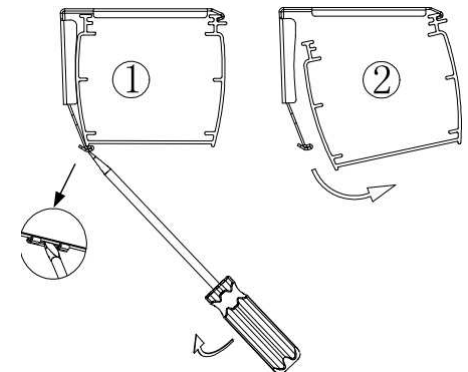

Cleaning Instructions

Perform periodic simple cleaning of your shade will keep your shade looking its best for the years to come. You can dust it with a duster or dusting mitten, or simply use a dry soft cloth to wipe the shade. Do not use detergent or abrasive cleaning solutions to clean the shade since it will likely cause damage to the shade.